

Varenummer: 3901250010300  
 Beskrivelse: Snekkegear med fri indgangsaksel  
 VF 250V-10-HS

## Mål

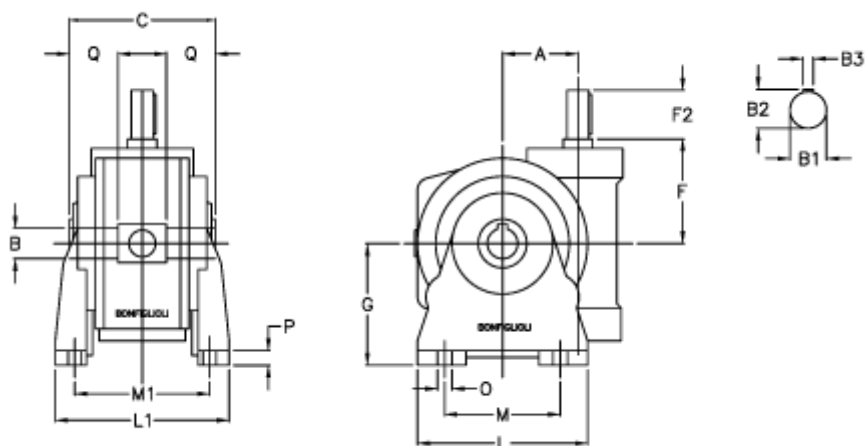

a	= 250.0	F2	= 110	Q	= 85.0
B	= 110	g	= 380		
B1	= 55	L	= 520		
B2	= 59.0	L1	= 380		
B3	= 16	m	= 400		
Betegnelse	= VF 250V-xx-HS	M1	= 310.0		
C	= 320	O	= 33.0		
F	= 276.0	P	= 30		